

ENERGIZER L91

Ultimate Lithium



AA

Industry Standard Dimensions

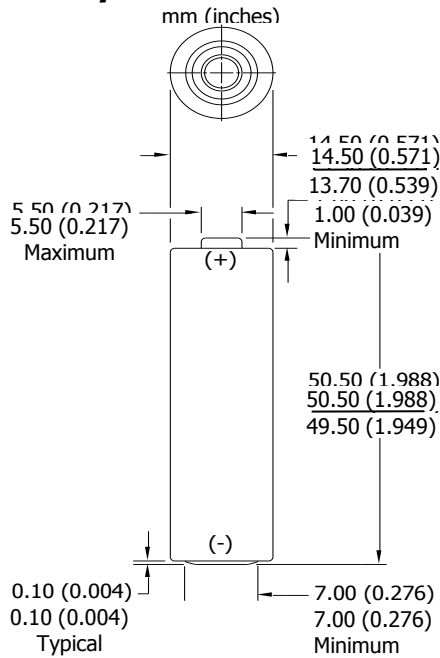

Specifications

Classification:	"Cylindrical Primary Lithium"
Chemical System:	Lithium/Iron Disulfide (Li/FeS ₂)
Designation:	ANSI 15-LF, IEC-FR14505 (FR6)
Nominal Voltage:	1.5 Volts
Sizing Compatibility:	E91 NH15 1215
Storage Temp:	-40°C to 60°C (-40°F to 140°F)
Operating Temp:	-40°C to 60°C (-40°F to 140°F)*
Typical Weight:	15 grams (0.5 oz.)
Typical Volume:	8.0 cubic centimeters (0.49 cubic inch)
Max Discharge:	2.5 amps continuous
(single battery only)	4.0 amps pulse (2 sec on / 8 sec off)
Lithium Content:	Less than 1 gram
Typical IR:	120 to 240 milliohms (depending on method)
Shelf Life:	20 years at 21°C
More Details:	On-Line Catalog-Application Manual (Li/FeS₂)
Shipping:	Please refer to PSDS Document
Certifications:	

*All data shown tested at 21°C unless otherwise stated.

Milliamp-Hours Capacity

Constant Current Discharge to 0.8 Volts

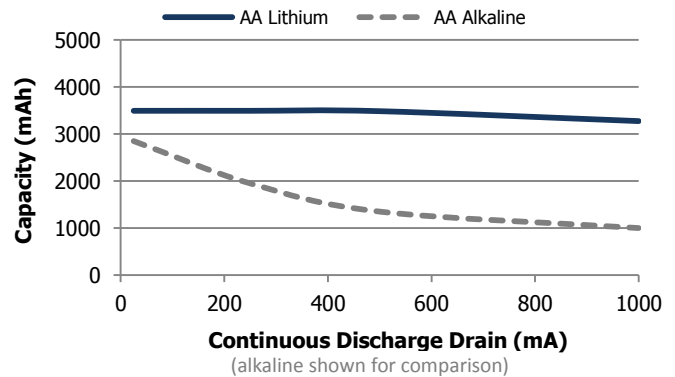

Discharge Profile

Constant Current Discharge

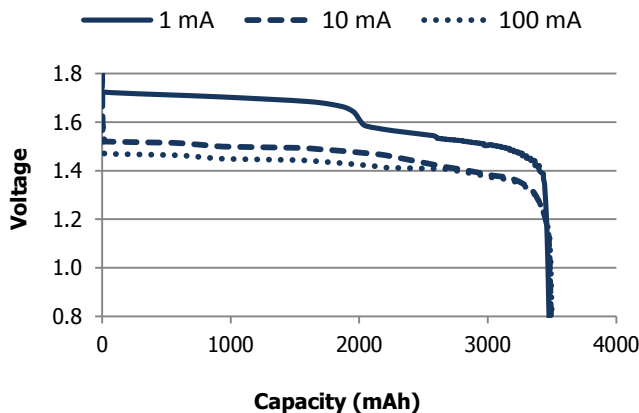

Temperature Effects on Capacity

Constant Current Discharge

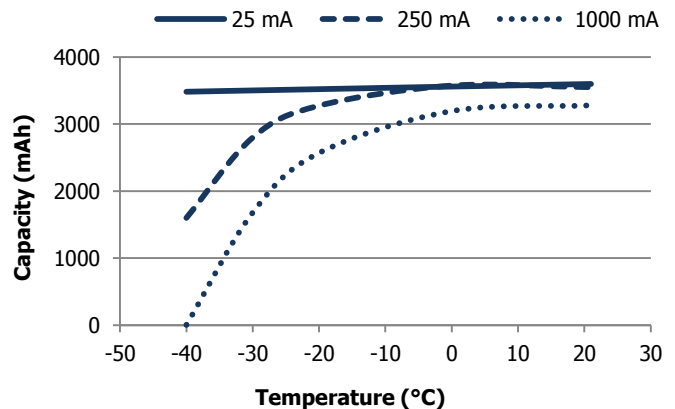

Important Notice

This datasheet contains typical information specific to products manufactured at the time of its publication. **Contents herein do not constitute a warranty and are for reference only.**

ENERGIZER L91

AA

Internal Resistance Profile

Cell Ohmic Resistance - Dual Pulse Method

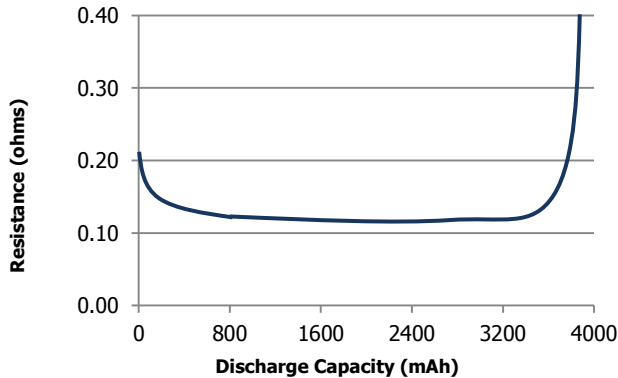

Pulse Response

Open Circuit Voltage - 100/500/1k mA Pulse

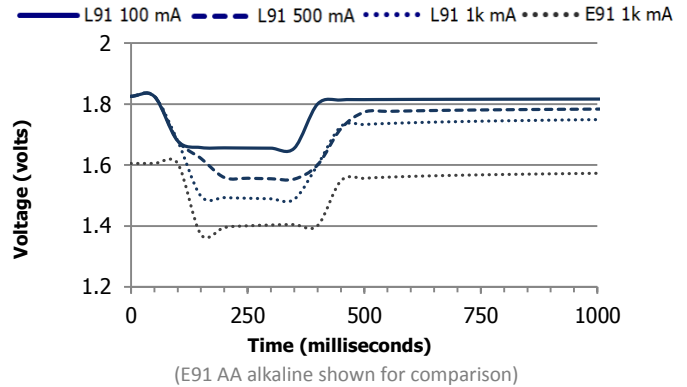

Constant Power Performance

Typical Characteristics to 0.8 Volts

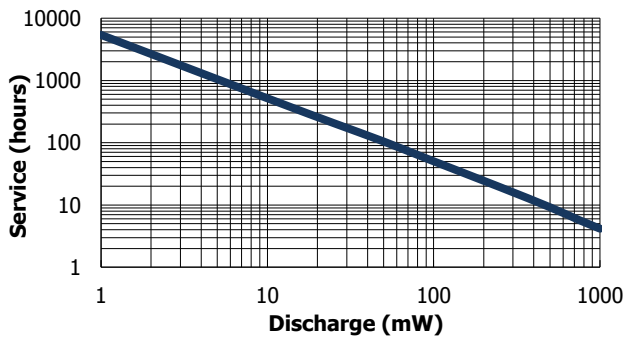

Constant Current Performance

Typical Characteristics to 0.8 Volts

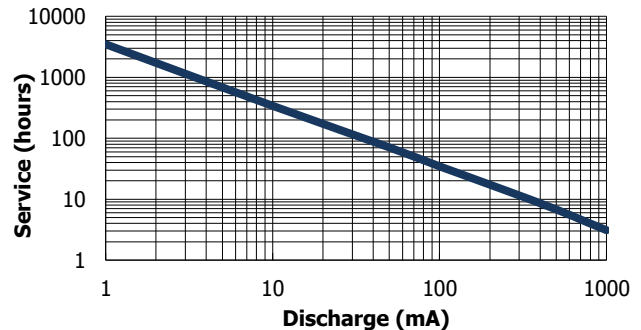

Application Tests

REMOTE/RADIO /CLOCK
50 mA 1 hr/8 hrs day

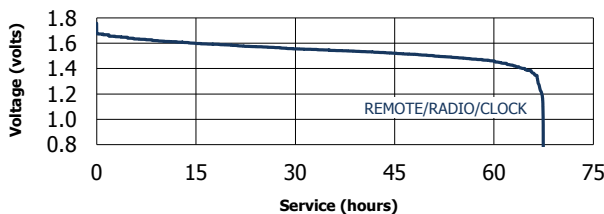

Application Tests

CD/GAMES
250 mA 1 hr/day

DIGITAL AUDIO
100 mA 1 hr/day

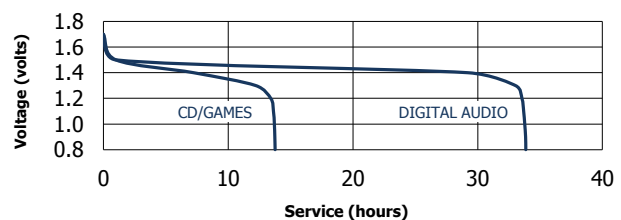

Application Tests

PORTABLE LIGHTING
3.3 ohm LIF

TOY
3.9 ohm 1 hr/day

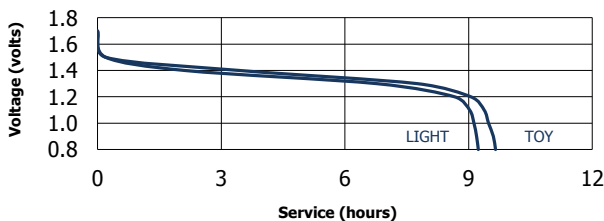

Industry Standard Tests

PERSONAL GROOMING
750 mA 2 min/hr 8 hrs/day

DIGITAL CAMERA
1.5/.65K mW 2/.1/27.9s 10X

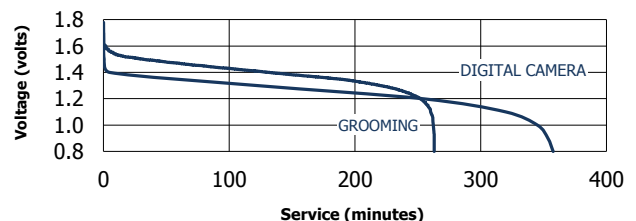

Important Notice

This datasheet contains typical information specific to products manufactured at the time of its publication.
Contents herein do not constitute a warranty and are for reference only.