

Type	: Rechargeable Nickel Metal Hydride Cylindrical Cell
Nominal Dimension (with Sleeve)	: $\Phi = 14.5\text{mm}$ H = 50.5mm
Applications	: Recommended discharge current 260 to 7800mA
Nominal Voltage	: 1.2V
Capacity	: Rated: 2600mAh Typical: 2650mAh When discharged at 520mA to 1.0V at 20°C
Charging Condition	: 260mA for 16 hrs at 20°C
Charging Retention	: 70% of nominal capacity after cell storage at 20°C for 6months, 50% of nominal capacity after cell storage at 20°C for 1year When discharged at 520mA to 1.0V at 20°C
Fast Charge	: 1300mA to 2600mA (0.5 to 1C) charge termination control recommended control parameters: - ΔV : 0-5mV DT/dt : 0.8°C/min (0.5 to 0.9C) 0.8 - 1°C/min (1C) TCO : 45 - 50°C Timer : 100% nominal input (for ref. only)
Service Life	: ~300 cycles (IEC standard)
Continuous Overcharge	: 260mA maximum current for 1 year. No conspicuous deformation and/or leakage
Weight	: 31.0g
Internal Resistance	: Average 20m Ω upon fully charged (Max.35m Ω) at 1000Hz
Max. Charging Voltage	: 1.5V at 260mA charging
Ambient Temperature Range	: Standard Charge : 0 to 45°C Fast Charging : 10 to 45°C Discharge : -20 to 50°C Storage : -20 to 35°C

Model No.: **GP270AAHC**

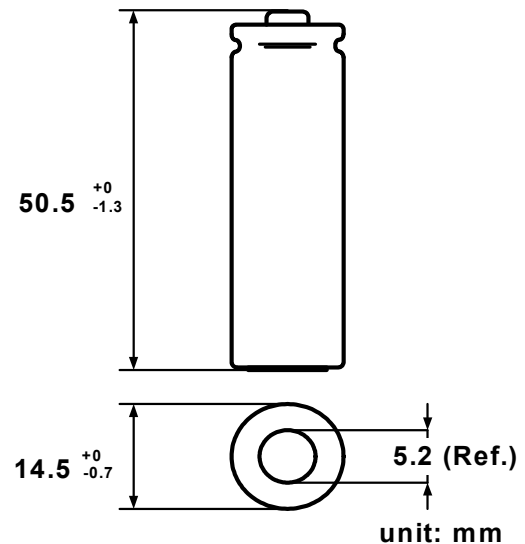

Low Rate Discharge

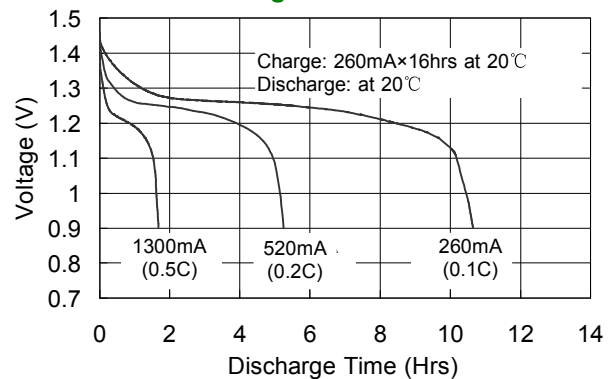

Fast Charge (Charge Control Required)

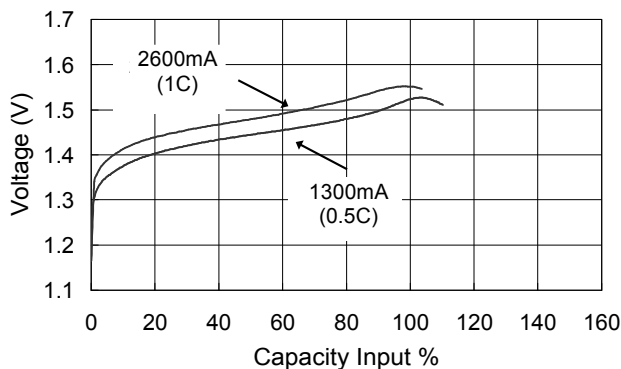

High Rate Discharge

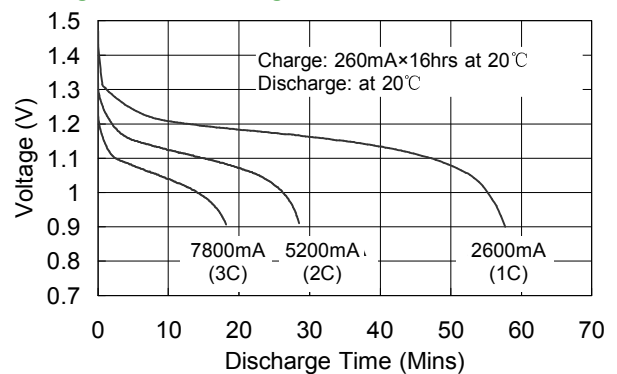

The information (subject to change without prior notice) contained in this document is for reference only and should not be used as a basis for product guarantee or warranty. For applications other than those described here, please consult your nearest GP Sales and Marketing Office or Distributors.